Comfort-Cire®

Century®

Installation & Operation Manual

VFH-B Series

Inverter Multi Zone Ductless Mini-Split

B-VFH09MB-1

B-VFH12MB-1

B-VFH18MB-1

B-VFH24MB-1





Content

Operation Notices

Precautions..... 1
 Parts Name..... 6

Screen Operation Guide

Buttons on remote controller.....7
 Introduction for icons on display screen.....7
 Introduction for buttons on remote controller..... 8
 Special functions.....13
 Operation guide..... 15
 Replacement of batteries in remote controller..... 15
 Emergency operation 16

Maintenance

Clean and Maintenance..... 16

Malfunction

Malfunction analysis 19

Installation Notice

Installation dimension diagram23
 Safety precautions for installing and relocating the unit24
 Tools for installation25
 Selection of installation location25
 Requirements for electric connection26

Installation

Installation of indoor unit.....27
 Check after installation32

Test and operation

Test operation32

Attachment

Configuration of connection pipe.....33

This appliance is not intended for use by persons (including children) with reduced physical, sensory or mental capabilities, or lack of experience and knowledge, unless they have been given supervision or instruction concerning use of the appliance by a person responsible for their safety. Children should be supervised to ensure that they do not play with the appliance.

If it needs to install, move or maintain the air conditioner, please contact dealer or local service center to conduct it at first. Air conditioner must be installed, moved or maintained by appointed unit. Otherwise, it may cause serious damage or personal injury or death.

 WARNING – USE THE RIGHT CABLE
Indoor Power Cable: 14 AWG/4 conductor, 600V THHN unshielded copper stranded <i>required</i>

Explanation of Symbols



Indicates a hazardous situation that, if not avoided, will result in death or serious injury.



Indicates a hazardous situation that, if not avoided, could result in death or serious injury.



Indicates a hazardous situation that, if not avoided, may result in minor or moderate injury.



Indicates important but not hazard-related information, used to indicate risk of property damage.



Indicates a hazard that would be assigned a signal word WARNING or CAUTION.

Precautions



WARNING

Operation and Maintenance

- This appliance can be used by children age 8 years and above and persons with reduced physical, sensory or mental capabilities or lack of experience and knowledge if they have been given supervision or instruction concerning use of the appliance in a safe way and understand the hazards involved.
- Children should not play with the appliance.
- Cleaning and user maintenance shall not be made by children without supervision.
- Do not connect air conditioner to socket. Otherwise, it may cause fire hazard.
- Do disconnect power supply when cleaning air conditioner. Otherwise, it may cause electric shock.
- If the supply cord is damaged, it must be replaced by the service agent or similarly qualified persons in order to avoid a hazard.
- Do not spray water on indoor unit. It may cause electric shock or malfunction.
- After removing the filter, do not touch fins to avoid injury.
- Do not use flame or hair dryer to dry the filter to avoid deformation or fire hazard.

Precautions



WARNING

- Maintenance must be performed by qualified professionals. Otherwise, it may cause personal injury or damage.
- Do not repair air conditioner by yourself. It may cause electric shock or damage. Please contact dealer when you need to repair air conditioner.
- Do not extend fingers or objects into air inlet or air outlet. It may cause personal injury or damage.
- Do not block air outlet or air inlet. It may cause malfunction.
- Do not spill water on the remote controller, otherwise the remote controller may be broken.
- When below phenomenon occur, please turn off air conditioner and disconnect power immediately, and then contact the dealer or qualified professionals for service.
 - Power cord is overheating or damaged.
 - There's abnormal sound during operation.
 - Circuit break trips off frequently.
 - Air conditioner gives off burning smell.
 - Indoor unit is leaking.
- If the air conditioner operates under abnormal conditions, it may cause malfunction, electric shock or fire hazard.
- When turning on or turning off the unit by emergency operation switch, please press this switch with an insulating object other than metal.
- Do not step on top panel of outdoor unit, or put heavy objects on it's top surface. It may cause damage or personal injury.

Precautions



WARNING

Attachment

- Installation must be performed by qualified professionals. Otherwise, it may cause personal injury or damage.
- Must follow the electric safety regulations when installing this unit.
- According to the local safety regulations, use qualified power supply circuit and circuit breakers.
- Do install circuit breakers. If not, it may cause malfunction.
- An all-pole disconnection switch having a contact separation of at least 3mm in all poles should be connected to fixed wiring.
- Include a circuit breaker with suitable capacity, please note the included table. It can protect the circuit-short and overload.
- Air Conditioner should be properly grounded. Incorrect grounding may cause electric shock.
- Don't use undersized power cord.
- Make sure the power supply matches the requirement of air conditioner. Please install proper power supply cables before using the air conditioner.
- Properly connect the live wire, neutral wire and grounding wire of power circuit.
- Be sure to cut off the power supply before proceeding with any work related to electricity and safety.

Precautions



WARNING

- Do not apply power before finishing installation.
- If the supply cord is damaged, it must be replaced by the service agent or similarly qualified persons in order to avoid a hazard.
- The temperature of refrigerant circuit will be high, please keep all cable away from the copper pipe.
- The appliance shall be installed in accordance with national wiring regulations.
- Installation must be performed in accordance with the requirement of NEC and CEC by authorized personnel only.
- The air conditioner is a first class electric appliance. It must be properly grounded with specialized grounding device by a professional. Please make sure it is always grounded effectively, otherwise it may cause electric shock.
- The yellow-green wire in air conditioner is grounding wire, which can't be used for other purposes.
- The grounding resistance should comply with national electric safety regulations.
- The appliance must be positioned so that the disconnect switch is accessible.
- All wires of indoor unit and outdoor unit should be connected by a professional.
- If the length of power connection wire is insufficient, please contact the supplier for a new one. Avoid extending the wire by yourself.

Precautions



WARNING

- A circuit breaker must be installed in the line.
- If you need to relocate the air conditioner to another place, only qualified technicians can perform the work. Otherwise, it may cause personal injury or damage.
- Select a location which is out of reach for children and far away from animals or plants. If it is unavoidable, please add a fence for safety.

Working temperature range

	Indoor side DB/WB(°C/°F)	Outdoor side DB/WB(°C/°F)
Maximum cooling	26.7/19.4(80/66.9)	46.1/23.9(115/75)
Maximum heating	26.7/-(80/-)	23.9/18.3(75/64.9)

NOTICE:

- The operating temperature range (outdoor temperature) for cooling only unit is -18°C(-0.4°F) ~ 46.1°C(115°F); for heat pump unit is -20°C(-4°F) ~ 46.1°C(115°F)

Parts Name

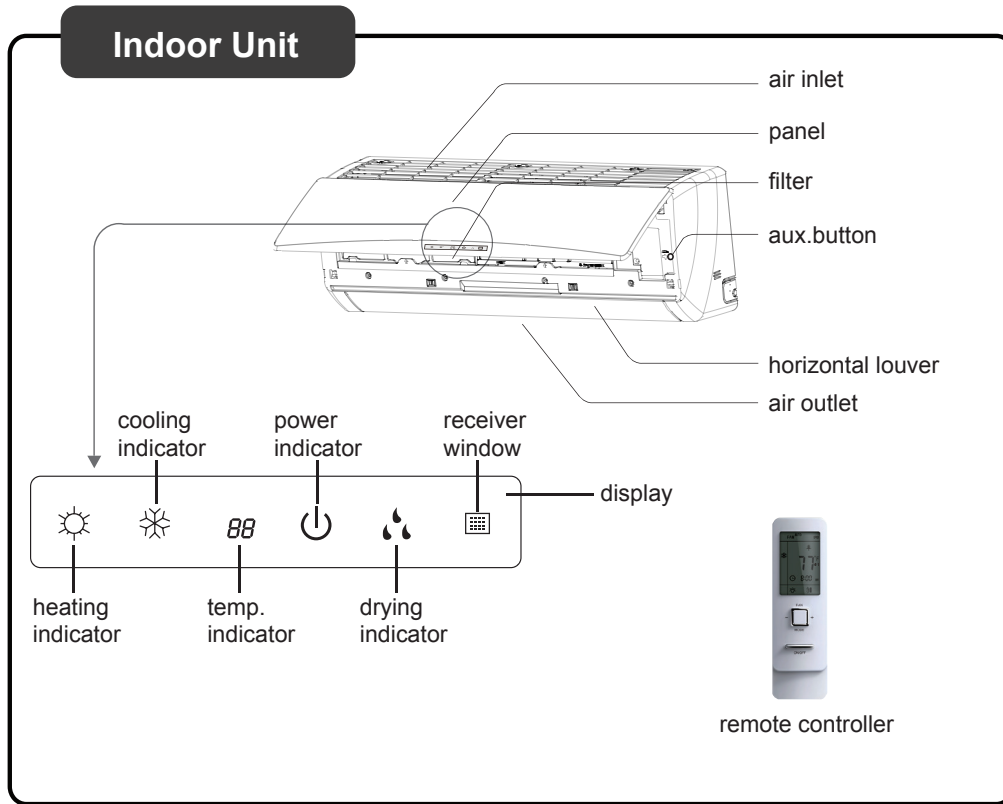

NOTICE:

Actual product may be different from above graphics, please refer to actual products.

Buttons on remote controller

(before opening cover)

- 1 ON/OFF button
- 2 FAN button
- 3 MODE button
- 4 +/- button

(after opening cover)

- 1 ON/OFF button
- 2 FAN button
- 3 MODE button
- 4 +/- button
- 5 TURBO button
- 6 button
- 7 button
- 8 CLOCK button
- 9 TIMER ON/TIMER OFF button
- 10 TEMP button
- 11 button
- 12 I FEEL button
- 13 LIGHT button
- 14 X-FAN button
- 15 QUIET button
- 16 SLEEP button

Introduction for icons on display screen

Operation mode

- Auto mode
- Cool mode
- Dry mode
- Fan mode
- Heat mode

Temp. display type

- : Set temp.
- : Indoor ambient temp.
- : Outdoor ambient temp.

- I feel
- Quiet
- Set fan speed
- Turbo mode
- Send signal
- Healthy mode
- Scavenging functions
- 8°C (46°F) heating function
- Set temperature
- This is a general remote controller. Some models have this function while some do not. Please refer to the actual models.
- X-FAN function
- Set time
- TIMER ON /TIMER OFF
- Child lock
- Up & down swing
- Left & right swing

Introduction for buttons on remote controller

Note:

- After applying power, the air conditioner will emit a sound. Operation indicator "⏻" is ON (red indicator). After that, you can operate the air conditioner by using remote controller.
- Under on status, pressing the button on the remote controller, the signal icon "📶" on the display of remote controller will blink once and the air conditioner will give out a sound, which means the signal has been sent to the air conditioner.
- Under off status, set temperature and clock icon will be displayed on the display of remote controller (If timer on, timer off and light functions are set, the corresponding icons will be displayed on the display of remote controller at the same time); Under on status, the display will show the corresponding set function icons.

1 ON/OFF button

Press this button, the unit will be turned on, press it once more, the unit will be turn-ed off. Sleep function will be canceled, while unit off.

2 FAN button

Press this button, Auto, Low, Medium-low, Medium, Medium-high, High speed can be selected. After powered on, Auto fan speed is default. Under DRY mode, Low fan speed only can be chosen.



Note: Only Low fan speed under Dry mode.

3 MODE button

Press this button, Auto, Cool, Dry, Fan, Heat mode can be selected. Auto mode is default when powered on. Under Auto mode, the temperature will not be displayed; Under Heat mode, the initial value is 28°C (82°F); Under other modes, the initial value is 25°C (77 °F).

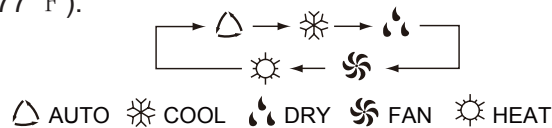

4 +/- button

- Presetting temperature can be increased. Press this button, the temperature can be adjusted up, continuously press this button and hold for two seconds, the setting will quickly change, release this button and send the order that the °C (°F) signal will be displayed all the time. The temperature adjustment is unavailable under the Auto mode. Temperature range 16-30°C; 61-86°F.

Introduction for buttons on remote controller

- Preset temperature can be decreased. Press this button, the temperature can be set up, press this button and hold for two seconds, the relative contents will quickly change. Releasing this button sends the order that the °C (°F) signal will be displayed all the time. Temperature adjustment is unavailable under the Auto mode.

5 TURBO button

Under Cool or Heat mode, pressing this button will turn on or turn off the Turbo function. After the Turbo function is turned on, the signal for Turbo will display. The signal will be automatically cancelled if changing the mode or fan speed.

6 button

Press this button to set left & right swing angle cycling as below:

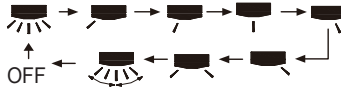

7 button

Press this button to set swing angle, as below:





This remote controller is universal. If it receives three kinds of following status, the swing angle will remain original.



If guide louver is stopped when it is swinging up and down, it will remain in its present position.

 indicates guide louver swings back and forth in the five positions, as shown in the figure.

8 CLOCK button

Press this button, the clock can be set up, signal  blink and display. Within 5 seconds, the value can be adjusted by pressing + or - button, if continuously press this button for 2 seconds above, the value will change 10 minutes every .5 seconds 1. During blinking, press the Clock button or Confirm button, signal  will be constantly displayed and it denotes the setting achieved. After powered on, 12:00 is defaulted to display and signal  will display the current time value, otherwise Timer value will be displayed.

9 TIMER ON/TIMER OFF button

- Timer On setting: Sign al “ON” will blink and display, signal  will conceal, the numerical section will become the timer on setting status. Within 5 seconds, press + or - button to adjust the time value of numerical section. With every press of that button, the value will be increased or decreased 1 minute. Press and hold + or -

Introduction for buttons on remote controller

button, in 2 seconds it will change: During the initial 2.5 seconds, ten numbers change in the one place of minute, then the one place is constant, ten numbers change in the tens place of minute at 2.5 seconds speed. During 5s blink, press the Timer button, the timer setting sets. The Timer On has been set up, repress the timer button, the Timer On will be canceled. Before setting the Timer, please adjust the Clock to the current time.

- Press this key to enter into TIMER OFF setup, the TIMER OFF icon will blink. The method of setting is the same as for TIMER ON.

10 TEMP button

- Press this button, you can see indoor set temperature, indoor ambient temperature or outdoor ambient temperature on indoor unit's display. The setting on remote controller is selected as below:

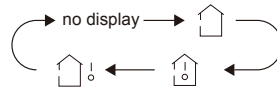

- When selecting "🏠" with remote controller or no display, temperature indicator on indoor unit displays set temperature; When selecting "🏠" with remote controller, temperature indicator on indoor unit displays indoor ambient temperature; When selecting "🏠+" with remote controller, temperature indicator on indoor unit displays outdoor ambient temperature. 3s later it will return to the setting temperature or it depends on the other received signal within 3s.

Attention: When displaying the outdoor ambient, the displaying range is 32-99 ℉ and 0-60 ℃. When it goes beyond the range, it keeps the threshold data (the smallest —0 ℃ or 32 ℉ and the largest 99 ℉ or 60 ℃).

Warm tips: When operating buttons on the cover please make sure the cover is closed completely.

11 🏠/🏠+ button

Press this button to achieve the on and off of healthy and scavenging functions in operation status. Press this button once to start scavenging function; LCD displays "🏠". Press the button again to start healthy and scavenging functions simultaneously; LCD displays "🏠" and "🌿". Press this button for the third time to stop healthy and scavenging functions simultaneously. Press the button for the fourth time to start healthy function; LCD display "🌿". Press this button again to repeat the operation above.

NOTE: This function is not available on all models.

12 I FEEL button

Press this button once, to turn on the I FEEL function, then the icon for "I FEEL" will be displayed, after every press of other function button, every 200ms to send I FEEL once, after this function is started, the remote controller will send temperature to the main unit in every 10 minutes. When repress this button, this function will be turned off.

Introduction for buttons on remote controller





13 LIGHT button

Press this button at unit On or Off status, Light On and Light Off can be set up. After powered on, Light On is defaulted.



14 X-FAN button

Pressing X-FAN button in COOL or DRY mode, the icon  is displayed and the indoor fan will continue operation for 2 minutes in order to dry the indoor unit even though you have turned off the unit. After energization, X-FAN OFF is defaulted. X-FAN is not available in AUTO, FAN or HEAT mode.

15 QUIET button

Press this button, the Quiet status is under the Auto Quiet mode (display " " and "Auto" signal) and Quiet mode (display " " signal) and Quiet OFF (there is no signal of " " displayed), after powered on, the Quiet OFF is defaulted. Under the Quiet mode (Display " " signal).

16 SLEEP button

- Press this button to select Sleep 1 (), Sleep 2 (), Sleep 3 () and cancel the Sleep, circulate between these, after electrified, Sleep Cancel is de-faulted. Sleep 1 is Sleep mode 1, in Cool, Dehumidify modes: sleep status after run for one hour, the main unit setting temperature will increase 1°C (1°F or 2°F), 2 hours, setting temperature increased 2°C (3°F or 4°F), the unit will run at this setting temperature; In Heat mode: sleep status after run for one hour, the setting temperature will decrease 1°C (1°F or 2°F), 2 hours, setting temperature will decrease 2°C, then the unit will run at this setting temperature.
- Sleep 2 is sleep mode 2, that air conditioner will run according to the presetting
- a group of sleep temperature curve.

In Cool mode:

- (1) When setting the initial temperature 16°C-23°C (61°F-74°F), after turning on Sleep function, the temperature will be increased 1°C (1°F-2°F) in every hour, after 3°C (5°F-6°F) the temperature will be maintained, after 7 hours, the temperature will be decreased 1°C (1°F-2°F), after that the unit will continue running at this temperature;
- (2) When setting the initial temperature 24°C-27°C (75°F-81°F), after turning on Sleep function, the temperature will be increased 1°C (1°F-2°F) in every hour, after 2°C (5°F-6°F) the temperature will be maintained, after 7 hours, the temperature will be decreased 1°C (1°F-2°F), after that the unit will continue running at this temperature;
- (3) When setting the initial temperature 28°C-29°C (82°F-85°F), after turning on Sleep function, the temperature will be increased 1°C (1°F-2°F) in every hour, after 1°C (1°F-1°F) the temperature will be maintained, after 7 hours, the temperature will be decreased 1°C (1°F-2°F), after that the unit will continue running at this temperature;

Introduction for buttons on remote controller

- (4) When setting the initial temperature 30°C (86°F), at this temperature setting, after 7 hours, the temperature will be decreased 1°C (1°F or 2°F), after that the unit will continue running under this temperature;

In Heat mode:

- (1) Under the initial presetting temperature 16°C (61°F), it will run at this setting temperature.
- (2) Under the initial presetting temperature 17°C- 20°C (62°F- 68°F), after Sleep function starts, the temperature will decrease 1°C (1°F or 2°F) in every hour, after 1°C (1°F or 2°F) decreased, this temperature will be maintained.
- (3) Under the initial presetting temperature 21°C- 27°C (69°F- 81°F), after Sleep function starts, the temperature will decrease 1°C (1°F or 2°F) every hour, after 2°C (3°F or 4°F) decreased, this temperature will be maintained.
- (4) Under the initial presetting temperature 28°C- 30°C (82°F- 86°F), after Sleep function starts the temperature will decrease 1°C (1°F or 2°F) in every hour, after 3°C (5°F or 6°F) decreased, this temperature will be maintained.

- Sleep 3 - the sleep curve setting under Sleep mode by DIY:

- (1) Under Sleep 3 mode, press and hold "Turbo" button, remote controller enters into user set sleep setting status, the time of remote controller will display "1hour", the setting temperature "88" will display the corresponding temperature of last sleep curve setting and blink (The first entry will display according to the initial curve setting from factory);
- (2) Adjust "+" and "-" button, will change the corresponding setting temperature, after adjusting, press "Turbo" button for confirmation;
- (3) Initial time setting is 1 hour. Timer can be advanced in 1 hour increments. "88" screen will flash corresponding temperature.
- (4) Repeat the above step (2)~(3) operation, until 8 hour temperature setting finished and sleep curve settings finished. At this time, the remote controller will resume the original timer display; temperature display will resume to original setting temperature.

- Sleep3 - the sleep curve setting under Sleep mode can be viewed: The user can access using sleep curve setting method to view the preset sleep curve, enter into user individual sleep setting status, but do not change the temperature, press "Turbo" button for confirmation.

Note: In the above presetting or inquiry procedure, if continuously within 10s, there is no button pressed, the sleep curve setting status will be automatically stopped and resume the original display. In the presetting or inquiry procedure, press "ON/OFF" button, "Mode" button, "Timer" button or "Sleep" button, the sleep curve setting or inquiry status will stop similarly.

Special functions

X-FAN function

This function indicates that moisture on evaporator of indoor unit will be blown dry after the unit is stopped to avoid mold.

1. Having set X-FAN function on: After turning off the unit by pressing ON/OFF button indoor fan will continue running for about 2 min. at low speed. In this period, press X-FAN button to stop indoor fan directly.
2. Having set X-FAN function off: After turning off the unit by pressing ON/OFF button, the complete unit will be off.

AUTO RUN

When AUTO RUN mode is selected, the setting temperature will not be displayed on the LCD, the unit will maintain the room temp. automatically to select the suitable running mode to make the space comfortable.



Turbo function

Using this setting, the unit will run at super-high fan speed to cool or heat quickly so that the ambient temp. approaches the preset temp. as soon as possible.



Lock

Press + and - buttons simultaneously to lock or unlock the keyboard. If the remote controller is locked, the icon  will be displayed on it, in which case, press any button, the icon will flash three times. If the keyboard is unlocked, the icon will disappear.

Swing up and down

1. Press swing up and down button continuously more than 2s, the main unit will swing back and forth from up to down. Release the button, the unit will stop swing and remain in present position.
2. Under swing up and down mode, when the status is switched from off to , press this button again 2s later,  status will switch to off status directly; press this button again within 2s, the change of swing status will also depend on the circulation sequence stated above.

Swing left and right

1. Press swing left and right button continuously more than 2s, the main unit will swing back and forth from left to right. Release the button, the unit will stop swing and present position of guide louver will be maintained.
2. Under swing left and right mode, when the status is switched from off to , press this button again 2s later,  status will switch to off; press this button again within 2s, the change of swing status will also depend on the circulation sequence stated above.

Special functions

Switching between Fahrenheit and Centigrade

With unit off, press MODE and - buttons simultaneously to switch °C and °F.

Combination of "TEMP" and "CLOCK" buttons: About Energy - saving Function

Press "TEMP" and "CLOCK" simultaneously in COOL mode to start energy-saving function. Screen on the remote controller displays "SE". Repeat to stop this function.

Combination of "TEMP" and "CLOCK" buttons: 8°C(46°F) Heating Function

Press "TEMP" and "CLOCK" simultaneously in HEAT mode to start 8°C(46°F) Heating Function. Screen on the remote controller displays "Ⓔ" and a selected temperature of "8°C" (46°F if Fahrenheit is adopted). Repeat the operation to quit the function.

Auto Quiet function

When quiet function is selected:

1. Under cooling mode: indoor fan operates at "4". 10 minutes later or when indoor ambient temperature $\leq 28^{\circ}\text{C}$ (82°F), indoor fan will operate at "2" or quiet mode according to the comparison between indoor ambient temperature and set temperature.
2. Under heating mode: indoor fan operates at "3" or quiet mode according to the comparison between indoor ambient temperature and set temperature.
3. Under dry, fan mode: indoor fan operates at quiet mode.
4. Under auto mode: the indoor fan operates at the auto quiet mode according to actual cooling, heating or fan mode.

Sleep function

Under the Fan and Auto mode, the Sleep function cannot be set up, under Dehumidify mode, only Sleep 1 can be selected. Select and enter into any kind of Sleep mode, the Quiet function will operate, different Quiet status can be set or turned off.

Operation guide

General operation

1. After powering on, press ON/OFF button, the unit will start to run. (Note: When it is powered on, the guide louver of main unit will close automatically.)
2. Press MODE button, select desired running mode.
3. Press + or - button, to set the desired temperature. (It is unnecessary to set the temp. at AUTO mode.)
4. Press FAN button, set fan speed, select AUTO FAN, LOW, MEDIUM-LOW, MEDIUM, MEDIUM-HIGH and HIGH.
5. Press and button, to select the swing.

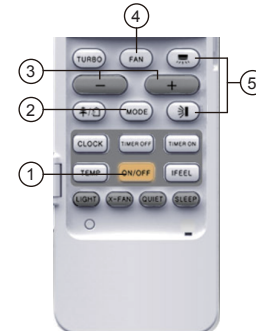

Optional operation

1. Press SLEEP button, to set sleep.
2. Press TIMER ON and TIMER OFF button to set the scheduled timer on or timer off.
3. Press LIGHT button to control the on and off of the displaying part of the unit (This function may be not available for some units).
4. Pressing TURBO button will initiate the ON and OFF TURBO function.

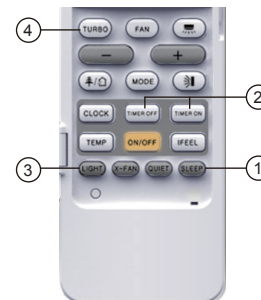

Replacement of batteries in remote controller

1. Press the back side of remote controller marked with "", as shown in the fig, and then push out the cover of battery box along the arrow direction.
2. Replace two 7# (AAA 1.5V) dry batteries, and make sure the position of "+" pole and "-" pole are correct.
3. Reinstall the cover of battery box.

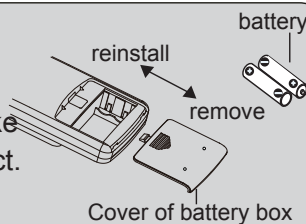

Note:

- During operation, point the remote control signal sender at the receiving window on indoor unit.
- The distance between signal sender and receiving window should be no more than 25 ft., and there should be no obstacles between them.
- Signal may be interfered easily by a fluorescent lamp or wireless telephone; remote controller should be close to indoor unit during operation.
- Replace new batteries of the same model when replacement is required.
- When you don't use remote controller for a long time, please take out the batteries.
- If the display on remote controller is fuzzy or there's no display, please replace batteries.

Emergency operation

If remote controller is lost or damaged, please use auxiliary button to turn on or turn off the air conditioner. Details are below:
 As shown in the fig. Open panel, press aux. button to turn on or turn off the air conditioner. When the air conditioner is turned on, it will operate under auto mode.

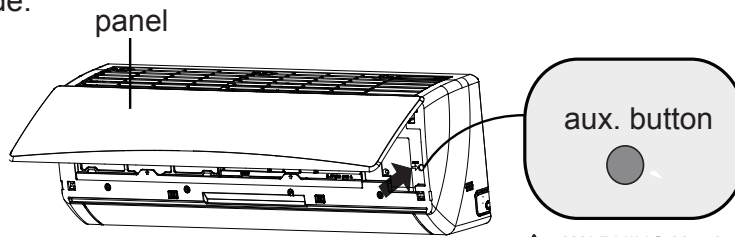

WARNING: Use insulated object to press the auto button

Clean and Maintenance

WARNING

- Turn off the air conditioner and disconnect the power before cleaning the air conditioner to avoid electric shock.
- Do not wash the air conditioner with water to avoid electric shock.
- Do not use volatile liquid to clean the air conditioner.

Clean surface of indoor unit

When the surface of indoor unit is dirty, it is recommended to use a soft dry cloth or wet cloth to wipe it.

NOTICE:

- Do not remove the panel when cleaning.

Clean and Maintenance

Clean filter

1 Open panel

Pull out the panel to angle as shown in the fig.

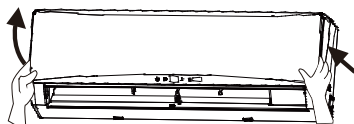

2 Remove filter

Remove the filter as indicated.



3 Clean filter

- Use dust catcher or water to clean the filter.
- When the filter is very dirty, use the water (below 45°C (113°F)) to clean it, and then put it in a shady and cool place to dry

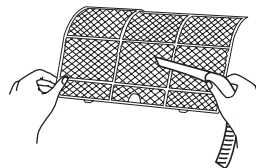

4 Install filter

Install the filter and then close the panel cover tightly.

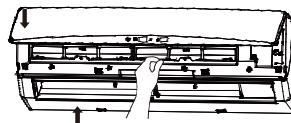

WARNING

- The filter should be cleaned every three months. If there is dust in the operating environment, cleaning frequency should be increased.
- After removing the filter, do not touch fins to avoid injury.
Do not use flame or hair dryer to dry the filter to avoid deformation or fire hazard.

Cleaning and Maintenance

NOTICE: Checking before use-season

1. Check whether air inlets and air outlets are blocked.
2. Check whether circuit breaker is in good condition.
3. Check whether filter is clean.
4. Check whether mounting bracket for outdoor unit is damaged or corroded.
If yes, please contact dealer.
5. Check whether drainage pipe is damaged.

NOTICE: Checking after use-season

1. Disconnect power supply.
2. Clean filter and indoor unit's panel.
3. Check whether mounting bracket for outdoor unit is damaged or corroded.
If yes, please contact dealer.

Notice for recovery

1. Many packing materials are recyclable materials.
Please dispose of them in appropriate manner.
2. If you want to dispose of the air conditioner, please contact local dealer or consultant service center for the correct disposal method.

Malfuction analysis

General phenomenon analysis

Please check below items before asking for maintenance. If the malfunction still can't be eliminated, please contact local dealer or qualified professionals.

Phenomenon	Check items	Solution
Indoor unit can't receive remote controller's signal or remote controller has no action.	<ul style="list-style-type: none"> • Voltage interference/static unstable voltage. 	<ul style="list-style-type: none"> • Disconnect power and reconnect after 3 minutes.
	<ul style="list-style-type: none"> • Is remote controller within the signal receiving range? 	<ul style="list-style-type: none"> • Signal receiving range is 25 ft.
	<ul style="list-style-type: none"> • Are there obstacles? 	<ul style="list-style-type: none"> • Remove obstacles.
	<ul style="list-style-type: none"> • Is the remote controller pointing at the receiving window? 	<ul style="list-style-type: none"> • Select proper angle and point the remote controller at the receiving window on indoor unit.
	<ul style="list-style-type: none"> • Is sensitivity of remote controller low; fuzzy display and no display? 	<ul style="list-style-type: none"> • Check the batteries. If the power of batteries is too low, please replace them.
	<ul style="list-style-type: none"> • No display when operating remote controller? 	<ul style="list-style-type: none"> • Check whether remote controller appears to be damaged. If yes, replace it.
	<ul style="list-style-type: none"> • Fluorescent lamp in room? 	<ul style="list-style-type: none"> • Take the remote controller close to indoor unit. • Turn off the fluorescent lamp and then try again.
No air emitted from indoor unit	<ul style="list-style-type: none"> • Is air inlet or air outlet of indoor unit blocked? 	<ul style="list-style-type: none"> • Eliminate obstacles.
	<ul style="list-style-type: none"> • Under heating mode, has indoor temperature reached set temperature? 	<ul style="list-style-type: none"> • After reaching set temperature, indoor unit will stop blowing out air.
	<ul style="list-style-type: none"> • Heating mode is just turned on now? 	<ul style="list-style-type: none"> • In order to prevent blowing out cold air, indoor unit will be started after delaying for several minutes, which is a normal phenomenon.

Malfunction analysis

Phenomenon	Check items	Solution
Air conditioner can't operate	<ul style="list-style-type: none"> • Power failure? 	<ul style="list-style-type: none"> • Wait until power recovery.
	<ul style="list-style-type: none"> • Is disconnect switch off? 	<ul style="list-style-type: none"> • Turn on switch.
	<ul style="list-style-type: none"> • Circuit breaker off or fuse is burnt out? 	<ul style="list-style-type: none"> • Ask professional to replace breaker or reset or fuse.
	<ul style="list-style-type: none"> • Wiring has malfunction? 	<ul style="list-style-type: none"> • Ask professional to replace or repair.
	<ul style="list-style-type: none"> • Unit has restarted immediately after stopping operation? 	<ul style="list-style-type: none"> • Wait for 3min, and then turn on the unit again.
	<ul style="list-style-type: none"> • Is the function setting for remote controller correct? 	<ul style="list-style-type: none"> • Reset the function.
Mist is emitted from indoor unit's air outlet	<ul style="list-style-type: none"> • Is indoor temperature and humidity high. 	<ul style="list-style-type: none"> • If indoor air is cooled rapidly, After a while, indoor humidity will decrease and mist will disappear.
Set temperature can't be adjusted	<ul style="list-style-type: none"> • Is unit operating under auto mode? 	<ul style="list-style-type: none"> • Temperature can't be adjusted under auto mode. Please switch the operation mode if you need to adjust temperature.
	<ul style="list-style-type: none"> • Your required temperature exceeds the set temperature range? 	<ul style="list-style-type: none"> • Set temperature range: 16°C ~30°C(61°F -86°F).
Cooling (heating) effect is not good.	<ul style="list-style-type: none"> • Voltage is too low? 	<ul style="list-style-type: none"> • Wait until the voltage resumes normal.
	<ul style="list-style-type: none"> • Filter is dirty? 	<ul style="list-style-type: none"> • Clean the filter.
	<ul style="list-style-type: none"> • Set temperature is in proper range? 	<ul style="list-style-type: none"> • Adjust temperature to proper range.
	<ul style="list-style-type: none"> • Door and window are open? 	<ul style="list-style-type: none"> • Close door and window.

Malfunction analysis

Phenomenon	Check items	Solution
Odours are emitted	<ul style="list-style-type: none"> Is there an odor source, such as furniture, cigarette, etc. 	<ul style="list-style-type: none"> Eliminate the odor source. Clean the filter.
Air conditioner operates abnormally	<ul style="list-style-type: none"> Is there interference, such as thunder, wireless devices, etc. 	<ul style="list-style-type: none"> Disconnect power, connect power, and then turn the unit on again.
Outdoor unit has vapor	<ul style="list-style-type: none"> Is heating mode turned on? 	<ul style="list-style-type: none"> During defrosting under heating mode, it may generate vapor, which is a normal phenomenon.
“Water flowing” noise	<ul style="list-style-type: none"> Was air conditioner just turned on or off? 	<ul style="list-style-type: none"> The noise is the sound of refrigerant flowing inside the unit, which is a normal phenomenon.
Cracking noise	<ul style="list-style-type: none"> Air conditioner has just been turned on or turned off. 	<ul style="list-style-type: none"> This is the sound of friction caused by expansion and/or contraction of panels or other parts due to the change in temperature.

Malfunction analysis

Error Code

- When air conditioner status is abnormal, temperature indicator on indoor unit will blink to display corresponding error code. Please refer to below list for identification of error code.

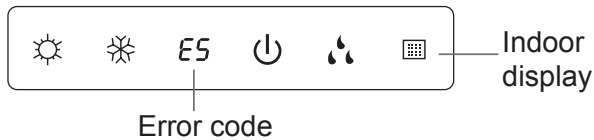

Above indicator diagram is only for reference. Please refer to your product for the actual indicator and position.

Error code	Troubleshooting
Heating indicator ON 10s OFF 0.5s	Means defrosting status. Normal phenomenon.
F1	Please contact qualified professionals for service.
F2	Please contact qualified professionals for service.
C5	Please contact qualified professionals for service.
H6	It may be eliminated by restarting the unit. If not, please contact qualified professionals for service.
E5	It may be eliminated by restarting the unit. If not, please contact qualified professionals for service.

Note: If there are other error codes, please contact qualified professionals for service.

WARNING

- When below phenomenon occurs, please turn off air conditioner and disconnect power immediately, then contact the dealer or qualified professionals for service.
 - Power cord is overheating or damaged.
 - There's abnormal sound during operation.
 - Circuit breaker trips off frequently.
 - Air conditioner gives off burning smell.
 - Indoor unit is leaking.
- Do not repair or refit the air conditioner by yourself.
- If the air conditioner operates under abnormal conditions, it may cause malfunction, electric shock or fire hazard.

Installation dimension diagram

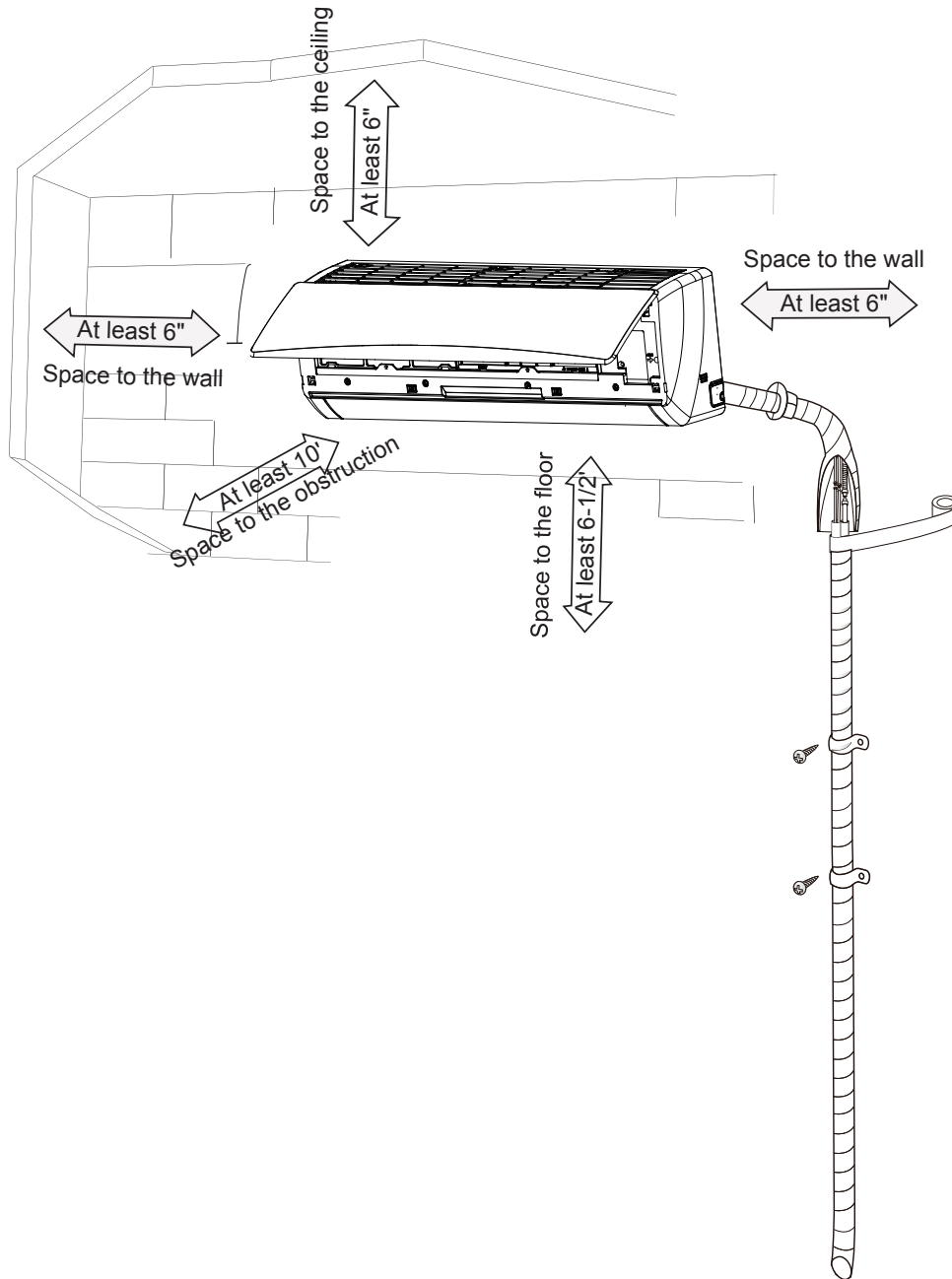

Safety precautions for installing and relocating the unit

To ensure safety, please be mindful of the following precautions.

Warning

- **When installing or relocating the unit, be sure to keep the refrigerant circuit free from air or substances other than the specified refrigerant.**
Any presence of air or other foreign substance in the refrigerant circuit will cause system pressure rise or compressor rupture, resulting in injury.
- **When installing or moving this unit, do not charge refrigerant other than that on the nameplate.** Otherwise, it may cause abnormal operation, mechanical malfunction or even serious injury.
When refrigerant needs to be recovered during relocating or repairing the unit, be sure that the unit is running in cooling mode. Then, fully close the valve at high pressure side (liquid valve). About 30-40 seconds later, fully close the valve at low pressure side (gas valve), immediately stop the unit and disconnect power. Please note that the time for refrigerant recovery should not exceed 1 minute.
If refrigerant recovery takes too much time, air may be sucked in and cause pressure rise or compressor rupture, resulting in injury.
During refrigerant recovery, make sure that liquid valve and gas valve are fully closed and power is disconnected before detaching the connection pipe.
If compressor starts running when stop valve is open and connection pipe is not yet connected, air will be sucked in and cause pressure rise or compressor rupture, resulting in injury.
- **When installing the unit, make sure that connection pipe is securely connected before the compressor starts running.**
If compressor starts running when stop valve is open and connection pipe is not yet connected, air will be sucked in and cause pressure rise or compressor rupture, resulting in injury.
- **Do not install the unit in a place where there may be corrosive gas or flammable gas.**
If there is leaked gas around the unit, it may cause explosion and other accidents.
- **Do not use extension cords for electrical connections. If the electric wire is not long enough, please contact a local service center authorized and ask for a proper electric wire.**
Poor connections may lead to electric shock or fire.
- **Use the specified types of wires for electrical connections between the indoor and outdoor units. Firmly clamp the wires so that their terminals receive no external stresses.**
Electric wires with insufficient capacity, wrong wire connections and insecure wire terminals may cause electric shock or fire.

Tools for installation

1 Level	2 Screw driver	3 Impact drill
4 Drill head	5 Pipe bender	6 Torque wrench
7 Open-end wrench	8 Pipe cutter	9 Leakage detector
10 Vacuum pump	11 Pressure gauges	12 Universal multi-meter
13 Inner hexagon spanner		14 Measuring tape

Note:

- Please contact the local agent for installation.
- Use only properly sized power cord.

Selection of installation location

Basic requirement	Indoor unit
<p>Installing the unit in the following places may cause malfunction. If it is un-avoidable, please consult the local dealer:</p> <ol style="list-style-type: none"> 1.Places with strong heat sources, or vapors, flammable or explosive gas, or volatile objects spread in the air. 2. Places with high-frequency devices (such as welding machines, medical equipment). 3.Near coastal areas. 4.Locations with oil or fumes in the air. 5.Areas with sulfurous gas. 6.This appliance shall not be installed in a laundry. 	<ol style="list-style-type: none"> 1. There should be no obstruction near air inlet and air outlet. 2. Select a location where the condensation water can be dispersed easily and won't affect other people. 3. Select a location which is convenient to connect the outdoor unit and near the power source. 4. Select a location which is out of reach for children. 5. Location should be able to withstand the weight of indoor unit and not increase noise and vibration. 6. The appliance must be installed 6-1/2 ft. above floor. 7. Don't install this indoor unit above any electric appliance. 8. Please try your best to keep away from fluorescent lamps.
Outdoor unit	
<ol style="list-style-type: none"> 1. Select a location where the noise and outflow air emitted by the outdoor unit will not affect neighborhood. 2. The location should be well ventilated and dry, where the outdoor unit won't be exposed directly to sunlight or strong wind. 3. The location should be able to withstand the weight of outdoor unit. 4. Make sure that the installation follows the requirement of installation dimension diagram. 5. Select a location which is out of reach for children and far away from animals or plants. If it is unavoidable, please add fence for safety purpose. 	

Requirements for electric connection

Safety precaution

1. Technician must follow the electric safety regulations when installing the unit.
2. According to the local safety regulations, use qualified power supply circuit and circuit breaker.
3. Make sure the power supply matches the requirement of air conditioner.
Unstable power supply or incorrect wiring will cause malfunction. Please install proper power supply cables before using the air conditioner.
4. Properly connect the live wire, neutral wire and grounding wire of power socket.
5. Be sure to cut off the power supply before proceeding with any work related to electricity and safety.
6. Do not apply the power before finishing installation.
7. If the supply cord is damaged, it must be replaced by the service agent or similarly qualified persons in order to avoid a hazard.
8. The temperature of refrigerant pipes will be high, please keep the interconnection cable away from the copper tube.
9. The appliance shall be installed in accordance with national wiring regulations.

Grounding requirement

1. This air conditioner is a first class electric appliance. It must be properly grounded with specialized grounding hardware by a professional. Please make sure it is always grounded effectively, otherwise it may cause electric shock.
2. The yellow-green wire in air conditioner is grounding wire, which should never be used for other purposes.
3. The grounding resistance should comply with national electric safety regulations.
4. The appliance must be positioned so that the disconnect switch is accessible.
5. An all-pole disconnect switch having a contact separation of at least 3mm in all poles should be connected in fixing wiring.

Installation of indoor unit

Step one: choosing installation location

Recommend the installation location to the client and then confirm it with the client.

Step two: install wall-mounting frame

1. Hang the wall-mounting frame on the wall; adjust it in horizontal position with the level meter and then pint ou the screw fixing holes on the wall.
2. Drill the screw fixing holes on the wall with impact drill (the specification of drill heat should be the same as the plastic wall anchors) and then install plastic wall anchors in the holes.
3. Fix the wall-mounting frame on the wall with tapping screws (ST4.2X25TA) and then check that the frame is firmly installed by pulling the frame. If the plastic wall anchor is loose, please drill another fixing hole nearby.

Step three: piping hole installation

1. Choose the position of piping hole according to the direction of outlet pipe. The position of piping hole should be a little lower than the wall-mounted frame, shown as below.

09、12K:

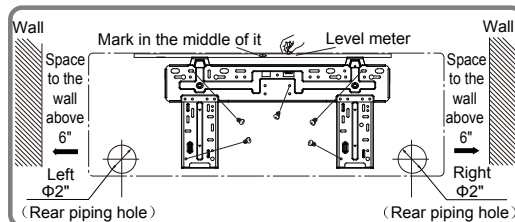

18K:

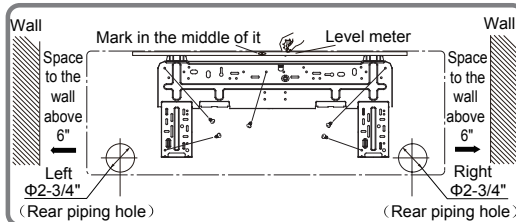

24K:

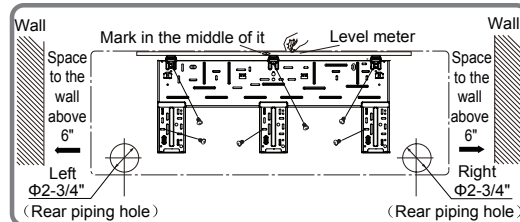

2. Open a piping hole with the diameter of $\Phi 2''/2-3/4''$ on the selected outlet pipe position. In order to drain smoothly, slant the piping hole on the wall slightly downward to the outdoor side with the gradient of $5-10^\circ$.

Installation of indoor unit

Note:

- Pay attention to dust prevention and take relevant safety measures when opening the hole.
- The plastic expansion particles are not provided and should be bought locally.

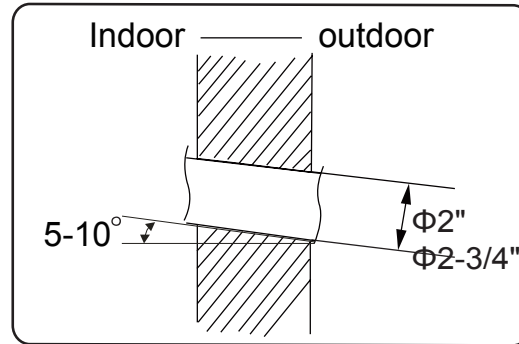

Step four: outlet pipe

1. The pipe can be led out in the direction of right, rear right, left or rear left.

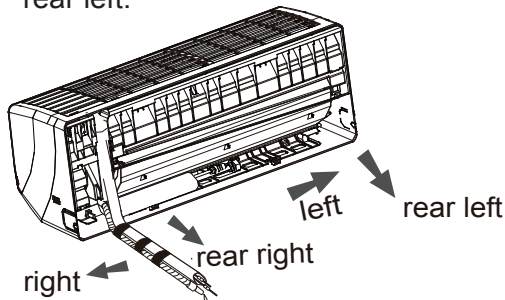

2. When selecting the piping configuration from left or right, please cut off the corresponding outlet hole on the bottom of the case.

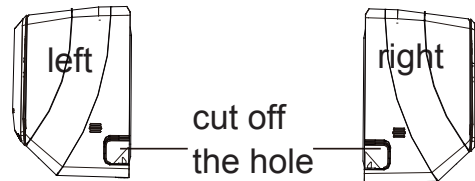

Step five: connect the pipe of indoor unit

1. Aim the pipe joint at the corresponding bellmouth.
2. Pretightening the union nut by hand.

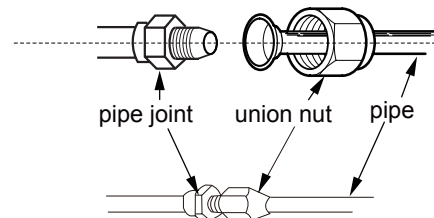

3. Adjust the torque force by referring to the following sheet. Place the open-end wrench on the pipe joint and place the torque wrench on the union nut. Tighten the union nut with torque wrench.

Installation of indoor unit

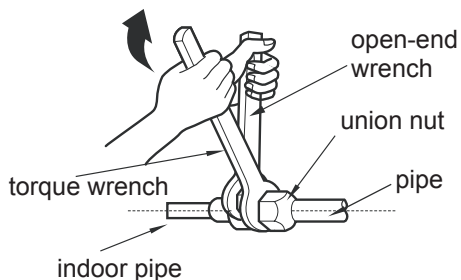

Hex nut diameter	Tightening torque (N·m)
Φ 1/4"	15~20
Φ 3/8"	30~40
Φ 1/2"	45~55
Φ 5/8"	60~65
Φ 3/4"	70~75

4. Wrap the indoor pipe and joint of connection pipe with insulating pipe, and then wrap it with tape.

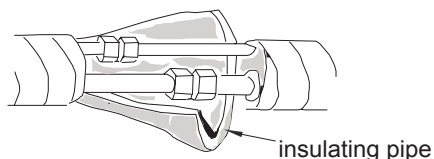

Step six: install drain hose

1. Connect the drain hose to the outlet pipe of indoor unit.

2. Bind the joint with tape.

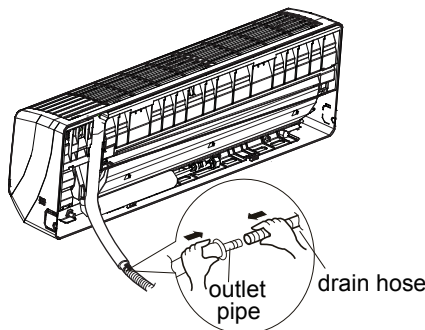
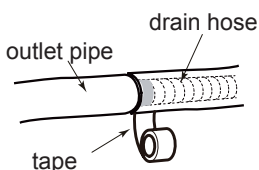

Note:

- Add insulating pipe in the indoor drain hose in order to prevent condensation.
- The plastic wall anchors are not provided.

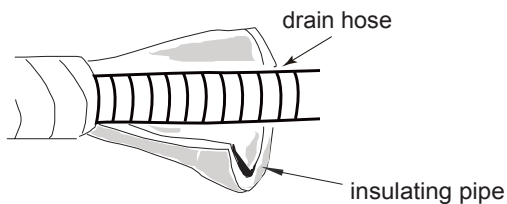

Step seven: connect wire of indoor unit

1. Open the panel, remove the screw on the wiring cover and then take down the cover.

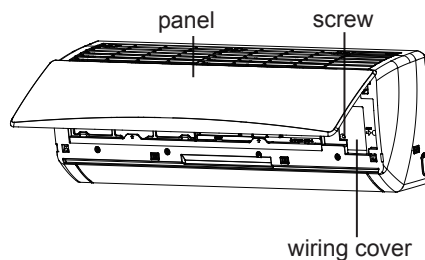

Installation of indoor unit

! WARNING – USE THE RIGHT CABLE

Indoor Power Cable: 14 AWG/4 conductor, 600V THHN unshielded copper stranded ***required***

2. Make the power connection wire go through the cable-cross hole at the back of indoor unit and then pull it out from the front side.

3. Remove the wire clip; connect the power connection wire to the wiring terminals according to the color; tighten the screw and then fix the power connection wire with wire clip.

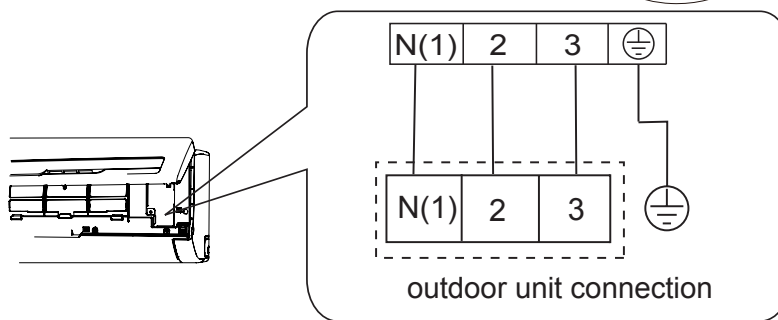
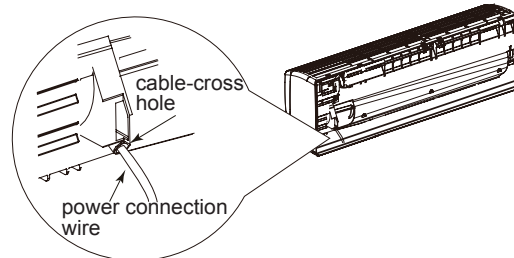

4. Put wiring cover back and then tighten the screw.
5. Close the panel.

Notice before installation

1. How to install conduit (According to the direction as show.)



2. Finish(According to the direction as show in right figure.)



Note:

- All wires of indoor unit and outdoor unit should be connected by a professional.
- If the length of power connection wire is insufficient, please contact the supplier. Avoid splicing the wire.
- For the air conditioner with plug, the plug should be reachable after finishing installation.
- A disconnect switch with breaker or fuse must be installed in the line. The disconnect breaker should be all-pole parting and the contact parting distance should be more than 3mm.

Installation of indoor unit

Step eight: bind up pipe

1. Bind up the connection pipe, power cord and drain hose with supplied band.

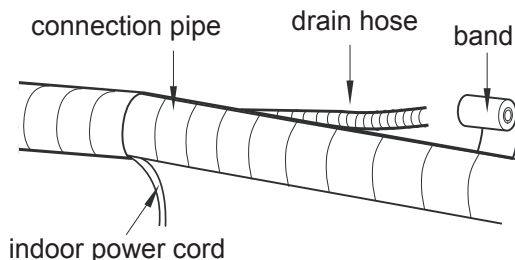
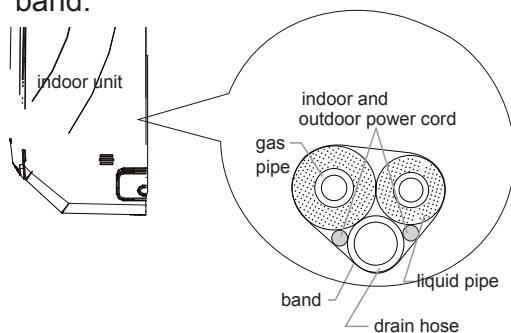

3. Bind them evenly.
4. The liquid pipe and gas pipe should be bound separately at the end.

Note:

- The power cord and control wire can't be crossed or wound.
- The drain hose should be bound at the bottom.

Step nine: hang the indoor unit

1. Put the bound pipes in the wall pipe and then make them pass through the wall hole.
2. Hang the indoor unit on the wall-mounting frame.
3. Stuff the gap between pipes and wall hole with sealing gum.
4. Fix the wall pipe.
5. Check if the indoor unit is installed firmly and close to the wall.

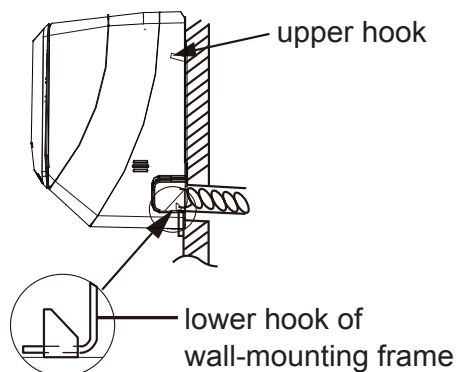
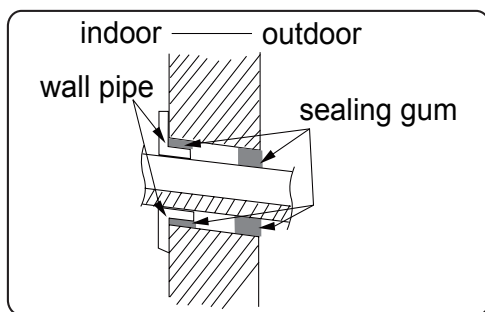

Note:

- Do not bend the drain hose too excessively in order to prevent blocking.

Check after installation

- Check according to the following requirement after finishing installation.

Items to be checked	Possible malfunction
Has the unit been installed firmly?	The unit may drop, shake or emit noise.
Have you done the refrigerant leakage test?	It may cause insufficient cooling (heating) capacity, or unit damage.
Is heat insulation of pipeline sufficient?	It may cause condensation and water dripping.
Does water drain well?	It may cause condensation and water dripping.
Does the voltage of power supply match the voltage marked on the nameplate?	It may cause malfunction or damage the parts.
Is electric wiring and pipeline installed correctly?	It may cause malfunction or damage parts.
Is the unit grounded securely?	It may cause electric leakage.
Does the power cord follow the specifications?	It may cause malfunction or damage parts.
Is there any obstruction in the air inlet and outlet?	It may cause insufficient cooling (heating) capacity.
The dust and debris caused during installation are removed?	It may cause malfunction or damage parts.
The gas valve and liquid valve of connection pipe are open completely?	It may cause insufficient cooling (heating) capacity.
Have the inlet and outlet of piping hole been filled?	It may cause insufficient cooling (heating) capacity or waster eletricity.

Test operation

1. Preparation of test operation

- The client approves the air conditioner.
- Specify the important features of the air conditioner to the client.

2. Method of test operation

- Turn on the power, press ON/OFF button on the remote controller to start operation.
- Press MODE button to select AUTO, COOL, DRY, FAN and HEAT to check for normal operation.
- If the ambient temperature is lower than 16°C , the air conditioner can't start cooling.

Configuration of connection pipe

1. Standard length of connection pipe
 - 16 ft., 25 ft.
2. Min. length of connection pipe is 10 ft.
3. Max. length of connection pipe indoor unit.

Cooling capacity	Max length of connection pipe
9000Btu/h	50 ft.
12000Btu/h	65 ft.
18000Btu/h	80 ft.

Cooling capacity	Max length of connection pipe
24000Btu/h	80 ft.

4. The additional refrigerant oil and refrigerant charging required after prolonging connection pipe
 - On piping over 35 ft. in length, you should add .17 oz. of refrigerant oil for each additional 16 ft. of connection pipe.
 - The calculation method of additional refrigerant charging amount (on the basis of liquid pipe):

Additional refrigerant charging amount = length of liquid pipe over 33 ft.
 × additional refrigerant charging amount foot

- Based on the length of standard pipe, add refrigerant according to the requirement as shown in the table. The additional refrigerant charging amount per ft. is different according to the diameter of liquid pipe. See the following sheet.

Configuration of connection pipe

Additional refrigerant charging amount for R410A.

Diameter of connection pipe		Outdoor unit throttle	
Liquid pipe(mm)			Cooling and heating(02 ft.)
Φ1/4"			.21
Φ3/8"			.54
Φ1/2"			1.3
Φ5/8"			1.3



LIMITED EXPRESS WARRANTY

Congratulations on purchasing your new HVAC equipment. It's been designed for long life and reliable service, and is backed by one of the strongest warranties in the industry. Your unit automatically qualifies for the warranty coverage listed below, providing you keep your proof of purchase (receipt) for the equipment and meet the warranty conditions.

LIMITED ONE (2) YEAR EXPRESS WARRANTY

MARS warrants all parts of the VFH Series Ductless Mini-Split to be free from defects in workmanship and materials for normal use and maintenance for two (2) years from the date of purchase by the original consumer for the original installation. This Express Limited Warranty applies only when the Ductless Mini-Split is installed as a complete matched system: outdoor unit and indoor unit, and only when the system is installed per MARS installation instructions and in accordance with all local, state and national codes for normal use.

LIMITED 3rd to 7th YEAR EXPRESS WARRANTY

The compressor only is warranted to be free from defects in workmanship and materials for normal use and maintenance for five (5) additional years, for a total of seven (7) years from the date of purchase by the original consumer for the original installation. This Express Limited Warranty applies only when the Ductless Mini-Split is installed as a complete matched system: outdoor unit and indoor unit, and only when the system is installed per MARS installation instructions and in accordance with all local, state and national codes for normal use.

EXCEPTIONS

The Limited Express Warranty does not cover normal maintenance—MARS recommends that regular inspection/maintenance be performed at least once a season and proof of maintenance be kept. Additionally, labor charges, transportation charges for replacement parts, replacement of refrigerant or filters, any other service calls/repairs are not covered by this Limited Warranty. It also does not cover any portion or component of the system that is not supplied by MARS, regardless of the cause of failure of such portion or component.

CONDITIONS FOR WARRANTY COVERAGE

- Unit must be operated according to MARS operating instructions included with the unit and cannot have been subjected to accident, alteration, improper repair, neglect or misuse, or an act of God (such as a flood)
- Installation was done by a trained, licensed or otherwise qualified HVAC dealer/contractor
- Performance cannot be impaired by use of any product not authorized by MARS, or by any adjustments or adaptations to components
- Serial numbers and/or rating plate have not been altered or removed
- Damage has not been a result of inadequate wiring or voltage conditions, use during brown-out conditions, or circuit interruptions
- Air flow around any section of the unit has not been restricted
- Unit remains in the original installation
- Unit was not purchased over the internet

DURATION OF WARRANTY & REGISTRATION

The warranty begins on the date of purchase by the original consumer. The consumer must retain a receipted bill of sale as proof of warranty period. Without this proof, the express warranty begins on the date of shipment from the factory.



Please visit www.marsdelivers.com to register your new product

REMEDY PROVIDED BY THE LIMITED EXPRESS WARRANTY

The sole remedy under the Limited Warranty is replacement of the defective part. If replacement parts are required within the period of this warranty, MARS replacement parts shall be used; any warranty on the replacement part(s) shall not affect the applicable original unit warranty. Ready access to the unit for service is the owner's responsibility. Labor to diagnose and replace the defective part is not covered by this Limited Express Warranty. If for any reason the replacement part/product is no longer available during the warranty period, MARS shall have the right to allow a credit in the amount of the current suggested retail price of the part/product instead of providing repair or replacement.

LIMITATION OF LIABILITY

1. There are no other express or implied warranties. MARS makes no warranty of merchantability. We do not warrant that the unit is suitable for any particular purpose or can be used in buildings or rooms of any particular size or condition except as specifically provided in this document. There are no other warranties, express or implied, which extend beyond the description in this document.
2. All warranties implied by law are limited in duration to the seven-year term of the parts warranty. Your exclusive remedy is limited to the replacement of defective parts. **We will not be liable for any consequential or incidental damages caused by any defect in this unit.**
3. This warranty gives you specific legal rights and you may also have other rights which vary from state to state. Some states do not allow limitation on how long an implied warranty lasts or do not allow the exclusion or limitation of incidental or consequential damages, so the above limitations or exclusions may not apply to you.
4. No warranties are made for units sold outside the continental United States and Canada. Your distributor or final seller may provide a warranty on units sold outside these areas.
5. MARS will not be liable for damages if our performance regarding warranty resolution is delayed by events beyond our control including accident, alteration, abuse, war, government restrictions, strikes, fire, flood, or other acts of God.

HOW TO OBTAIN WARRANTY SERVICE OR PARTS

If you have a warranty claim, notify your installer promptly. If the installer does not remedy your claim, write to MARS, 1900 Wellworth Ave., Jackson MI 49203. Enclose a report of inspection by your installer or service person. Include model number, serial number, and date of purchase.

Owner responsibilities are set forth in the instruction manual—read it carefully.

KEEP THIS INFORMATION AS A RECORD OF YOUR PURCHASE

Outdoor Unit: Model No. _____ Serial No. _____

Indoor Unit 1: Model No. _____ Serial No. _____

Indoor Unit 2: Model No. _____ Serial No. _____

Indoor Unit 3: Model No. _____ Serial No. _____

Indoor Unit 4: Model No. _____ Serial No. _____

Indoor Unit 5: Model No. _____ Serial No. _____

Date of Purchase _____

Due to ongoing product improvements, specifications and dimensions are subject to change and correction without notice or incurring obligations. Determining the application and suitability for use of any product is the responsibility of the installer. Additionally, the installer is responsible for verifying dimensional data on the actual product prior to beginning any installation preparations.

Incentive and rebate programs have precise requirements as to product performance and certification. All products meet applicable regulations in effect on date of manufacture; however, certifications are not necessarily granted for the life of a product. Therefore, it is the responsibility of the applicant to determine whether a specific model qualifies for these incentive/rebate programs.

Comfort-Cire® 

1900 Wellworth Ave., Jackson, MI 49203 • Ph. 517-787-2100 • www.marsdelivers.com

